



BOSCH

U11002



FIAT DOBLO/ STRADA

REPARACIÓN UR0170/UR0171

FC000C60004/005 **53 DTS/10 EST / Ø10mm**

BOSCH

TIPO EV

U11003



**FIAT DUCATO/ FORD F250
PEUGEOT BOXER/
CITROEN JUMPER**

REPARACIÓN UR0107/UR0128

0001223001/ 0001223013 **40 DTS / 16 EST/Ø12mm**

BOSCH

U11010



ZEN-12683

**ASTRA / BLAZER/ S10/
VECTRA/ ZAFIRA**

37 DTS / 10 EST/ Ø12mm

BOSCH

TIPO DW

U11015



ZEN-12685

ESCORT / SEAT/ VW

37DTS Ø12mm

BOSCH

TIPO DW

U11019



ZEN-12681

VOLKSWAGEN GOL/

37 DTS 10E Ø12mm

BOSCH

U11025



FIORINO 1.7D/ IVECO

0.001.110.025 **42 DTS 10E Ø12mm**

BOSCH

U11029



**NISSAN MEXICO
V-16**

36 DTS / 10E/ Ø10/12mm

BOSCH

TIPO DW

U11037



ZEN-12689

TEMPRA 2.0/ PALIO 1.6

37 DTS/ 10E/ Ø12mm

BOSCH

U11056



**MBB 180D /
SSANGYONG MUSSO 2.9D**

42 DTS /10E/ Ø12mm

BOSCH

U11058



**ASTRA 2.0/VECTRA 2.0/
ZAFIRA 2.0**

37 DTS /10E/ Ø12mm



BOSCH
TIPO DW



U11059

CHRYSLER DAKOTA 2.5D/
MERCEDES BENZ C180

37DTS/10E/ Ø10-10.9mm

BOSCH



U11067

ASTRA/BLAZER/S10/

42 DTS /10E/ Ø12mm

BOSCH



U11079

FIAT DUCATO 2.3
PEUGEOT BOXER
CITROEN JUMPER

37 DTS /10E/ Ø10-12mm

BOSCH
Ø14,5mm / 12mm 10E



U11090

FORD F250/350
CUMMINS

40 DTS /10E/ Ø12-14,2mm

BOSCH



U11099

DUCATO 2.3/2.8
STRADA 1.9D /1.7TD
SPRINTER 312D/
NISSAN NAVARA

38 DTS /10E/ Ø12mm

BOSCH
TIPO DW



U11104

SILVERADO 4.1/ BRAVA
MAREA / CLIO 2.0/
LAGUNA 2.0

37 DTS /10E/ Ø12mm

BOSCH



U11111

HILUX /SW4/ 2.5/2.8/3.0D
F000 AL0 111

EJE 94,7mm
37 DTS /10E/ Ø12mm

BOSCH



U11123

VW/RENAULT/CITROEN/
OPEL/AUDI/

EJE 92,5mm
36 DTS /10E/ Ø12mm

BOSCH



U11126

VW LT 2.5D/ LT 2.5 TD

EJE 81,1mm
38 DTS /16E/ Ø7,9-14,2mm

BOSCH
TIPO DW



U11128

ZEN-12690

VW GOLF 1.8/FIAT
TEMPRA 2.0

EJE 92,5mm
37 DTS /10E/ Ø10,9-12mm



BOSCH

U11138

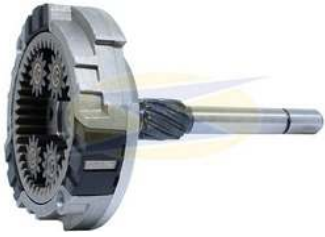

**MARCOPOLO VOLARE
SPRINTER /312**

**EJE 103,7mm
42 DTS /10E/ Ø12mm**

BOSCH

U11173



**BOSCH EV
SCANIA**

**EJE 91,2mm
41 DTS /14E/ Ø18mm**

BOSCH

U11218



**CITROEN JUMPER 2.8HDI
DUCATO 2.3/ BOXER
2.8 HDI**

**EJE 96,3mm
38 DTS /10E/ Ø12mm**

BOSCH

U11220



**HILUX D4D/ SW4/YARIS
COROLLA/ RAV4**

**EJE 94,7mm
37 DTS /10E/ Ø12mm**

BOSCH

U11244



**MMB 712C/ 914C/ LO
ACCELO 915C/ 915E/
VOLVO FM7/ 1017/ 1215C**

**EJE 130,80mm
41DTS/10E/ Ø14,2-12,4mm**

9001336244

BOSCH

U11358



**FIAT BRAVO/STRADA
MBB SPRINTER 515 Cdi**

**EJE 91,1mm
40 DTS /16E/ Ø8-14,2mm**

0001121440

BOSCH

U11367



**VW GOLF/ JETTA/
NEW BEETLE/TIGUAN
TOURAN**

**EJE 91,2mm
37 DTS /16E/ Ø8-10,9mm**

0001121402/ 0001121435

BOSCH

U11369



**MBB SPRINTER 311 Cdi
415/515 Cdi/ BMW 325**

**EJE 79,3mm
37 DTS /10E/ Ø10-10,9mm**

F000AL0901/ F000AL0903

BOSCH

U11408



**MBB SLK / SERIE C/
E200 1.8 / C200 2.0**

**EJE 86,5mm
37 DTS /10E/ Ø9,9-11,9mm**

0001147408 / 0001147409

BOSCH

U11477

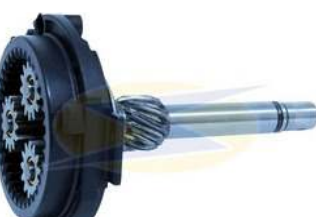

**RENAULT CLIO/DUSTER
LAGUNA 2.0/ SCENIC**

**EJE 79,4mm
36 DTS /10E/ Ø10-11mm**

0001107433/ 0001107438



**IMPORTADORA
ISIS**

**Importación, Exportación
y Comercialización de Repuestos
de Vehículos**
Ignacio Carrera Pinto #1161, Rancagua.
Fono: 72-2-583570
ventas@importadoraisis.cl



BOSCH

U11493



**MBB SPRINTER/ VITO
KOMPRESSOR
FIAT STILO/ PUNTO
MAREA
EJE 79,2mm
37 DTS /16E/ Ø13,9-10mm**

0001107401/ 0001107402

BOSCH

U11508



**AUDI A4/ A5/ QUATTRO
Q5/ PORSCHE
EJE 93mm
36 DTS /10E/ Ø11,9mm**

1006200454

BOSCH

U11512



**MBB SPRINTER/ VITO
KOMPRESSOR
FIAT STILO/ PUNTO
MAREA
EJE 93,8mm
36 DTS /10E/ Ø12mm**

000115089

BOSCH

U11514

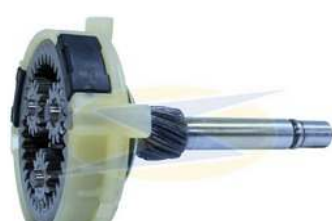

**COROLLA 1.8/2.0
CITROEN C1 1.0
PEUGEOT 107
BMW 116
EJE 79,4mm
36 DTS /10E/ Ø10mm**

0001107456

BOSCH

U11588



**TOYOTA HILUX 2.8/3.0D
SW4 2.8D
EJE 91,2mm
36 DTS /16E/ Ø14,2/10,9mm**

0001124028 / 0001125626

BOSCH

U11590



**FIAT DUCATO 2.5D/
MBB 310 SPRINTER
DODGE DAKOTA 2.5D
GM BLAZER 2.5D
EJE 103,9mm
42 DTS /10E/ Ø12mm**

BOSCH

U11625



**FORD CARGO C
MBB SPRINTER 515 Cdi
EJE 106,1mm
37 DTS /10E/ Ø12mm**

F000AL2625

BOSCH

U11663



**CHEVROLET TRACKER 1.0
EJE 95,3mm
37 DTS /16E/ Ø10mm**

0001170663

BOSCH

U11727



**FORD CARGO C1317/ 1319
1517/1519/1717/1719
2422/2423
EJE 136,1mm
40 DTS /10E/ Ø12-14,2mm**

F002G20904

BOSCH

U11779



**FORD CARGO C814/815/
MBB / MWM/ VALMET
NEW HOLLAND
EJE 108,4mm
38 DTS /10E/ Ø12mm**

F000AL0128



DELCO
C/RODAMIENTO

U14032



28MT

CUMMINS 4BT/6BT/6BT
MBB 710/1418R/L1620/
OM364/OM366
EJE 172mm
31 DTS /12E/ Ø14mm

DELCO

U14057



8000357/ 36100-2G200

KIA SPORTAGE 2.0
HYUNDAI SANTA FE
SONATA/ TUCSON
EJE 73,3mm
42 DTS /8E/ Ø12mm

DELCO

U14095



TIPO 38MT

FORD CARGO 1622/1630
2422/2622/4030
VW 17220/ 19320/ 31320
C/MOTOR 8.3L
EJE 97,4mm
48 DTS /12E/ Ø12,9mm

DELCO

U14150



ZEN-12720

ASTRA/ BLAZER/ S10/
VECTRA II
EJE 76,9mm
50 DTS /12E/ Ø12mm

DELCO

C/RODAMIENTO

U14357



MBB 712C/914C/915C/
1218L/1417/OM904 24V

EJE 175,4mm
31 DTS /12E/ Ø14mm

DELCO

TIPO PG260D



U14368

GM-CHEVROLET ASTRA/
BLAZER/ S10/ VECTRA II
16V

EJE 80,7mm
50 DTS /12E/ Ø12mm

DELCO

U14410

TIPO 39MT



CUMMINS/ CASE
NAVISTAR/ CATERPILLAR
NEW HOLLAND

EJE 97,4mm
48 DTS /12E/ Ø13mm

8200032/ 8200291

DELCO

TIPO PG260B

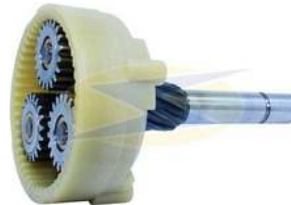

U14525

CHEVROLET ONIX
PRISMA

EJE 71,5mm
50 DTS /8E/ Ø12mm

DELCO

U14534

UR0181/ UR0182

HYUNDAI HR 2.5/ H1 2.5
KIA BONGO K2500 2.5 TCI

EJE 80,2mm
48 DTS /12E/ Ø10-12mm

8000534/ 36100-4A150

DELCO

TIPO PG260D



U14711

CHEVROLET/ GM

EJE 73mm
43 DTS /8E/ Ø10,6mm



DELCO

**U14811
TIPO 29MT**



**MBB /VW/ FORD/ VOLVO
IMPULSOR 6 ESTRIAS
EJE 79,2mm
44 DTS /12E/ Ø12mm**

DELCO

U14812



**TIPO 29MT
MBB /VW/ FORD/ VOLVO
IMPULSOR 7 ESTRIAS
EJE 79,2mm
44 DTS /14E/ Ø12mm**

DELCO

U14868

UR0183



**HYUNDAI HR 2.0/ H1 2.5/
PORTER/ KIA BONGO K2500
EJE 79,2mm
46 DTS /8E/ Ø11,9-10mm**

8000868 / 36100-4A160

DELCO

TIPO PG260G

U14890



**BLAZER/S10
C/MOTOR VORTEC V6 4.3
EJE 80,4mm
43 DTS /12E/ Ø12mm**

DELCO

U14910

**PG260M / PMGR
CHEVROLET GM**



**EJE 93mm
48 DTS /12E/ Ø12mm**

DELCO

U17210



**JEEP WRANGLER
CHARGER/ DURANGO V6
EJE 72,2mm
41 DTS /10E/ Ø13,9-10mm**

428000-7200



DENSO

U17011



HONDA ACCORD 2.0/
CIVIC 1.6/ CRV 2.0

REPARACIÓN UR0189/R0190
EJE 99,4mm
43 DTS /10E/ Ø11mm

428000-5011

DENSO

U17190



HONDA RIDGELINE 3.5/
HONDA PILOT 3.5/
HONDA NEW CIVIC

REPARACIÓN UR0169
EJE 84,7mm
37 DTS /10E/ Ø10,9-10mm

428000-8190 / 428000-5380

DENSO

U17330



DODGE RAM 2500 5.9/
RAM 2500 6.7/ RAM 3500

REPARACIÓN UR0199
EJE 163,4mm
39 DTS /12E/ Ø16,3-20mm

428000-3330/ 428000-6980

DENSO

U17400



JEEP GRAND CHEROKEE
CHRYSLER

REPARACIÓN UR0164
EJE 82,5mm
42 DTS /10E/ Ø10-11mm

428000-7400

DENSO

U17414



CATERPILLAR 320D
JOHN DEERE 370E/

REPARACIÓN UR0198
EJE 195mm
41 DTS /16E/ Ø16,9mm

428000-0130 / 428000-3860

DENSO

U17420



FORD F150/ F1000/F4000

REPARACIÓN UR0136
EJE 72,2mm
42 DTS /10E/ Ø10-11mm

428000-8420

DENSO

U17490



BMW 116i /118i/ 523 2.5i

EJE 72,8mm
42 DTS /10E/ Ø10-11mm

428000-4490

DENSO

U17640



JEEP WRANGLER 3.8L
CHRYSLER

EJE 88,4mm
43 DTS /10E/ Ø11mm

428000-6640

DENSO

U17902



TOYOTA RAV4 / AVENSIS

REPARACIÓN UR0200
EJE 73,8mm
55 DTS /10E/ Ø10,9mm

428000-5880 / 428000-0152

DENSO

U17950



RANGE ROVER SPORT/
DISCOVERY 2.7/

REPARACIÓN UR0206/UR0207
EJE 75,4mm
37 DTS /10E/ Ø12mm

428000-5950 / 428000-4880



ISKRA

U18446



JCB

EJE 131,2mm
42 DTS /10E/ Ø14,2mm

AZE4181/ AZE4186/ AZE4576

ISKRA

U18622



CASE / M FERGUSON/
VALTRA/ J DEERE

EJE 131,4mm
38 DTS /14E/ Ø14,2mm

16911622 / MSX522

ISKRA

U18623



BOBCAT/ JOHN DEERE/
IVECO/ NEW HOLLAND
HR100

EJE 120,90mm
38 DTS /14E/ Ø14,15mm

AZE4139/ AZE4150/ AZE4199

ISKRA

U18628



VOLVO L20B/ L25B
ATLAS COPCO/ KHD

EJE 102,9mm
38 DTS /14E/ Ø12mm

16911628

ISKRA

U18832



JOHN DEERE/ ZETOR/
VALTRA/ M FERGUSON
NEW HOLLAND/ CASE

EJE 131,20mm / 24,90mm
42 DTS /10E/ Ø14,15mm

AZF4508/ AZF4141/ AZF4577

ISKRA

U18944



HATZ 1B4005/ JCB

REPARACIÓN UR0160
EJE 131,20mm / 24,90mm
42 DTS /10E/ Ø14,2mm

11131995/ 11132230

ISKRA

U18979



NEW HOLLAND CX720/
CX740/ CX760/CX820/CX840

EJE 130,90mm / 24,70mm
42 DTS /10E/ Ø14,2mm

11130941/ IS1120/ AZF4595



JHEECO

U14104



JAC J3 1.4/ J5

REPARACIÓN UR0204/0205
EJE 73mm
38 DTS /8E/ Ø9,9/11,9mm

1043100GG01C

JHAEM

U14289

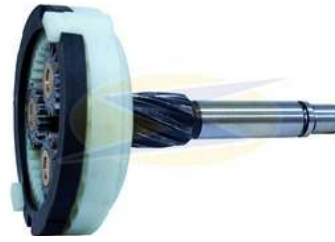

JAC J3/ J2 1.4

REPARACIÓN UR0213/0214
EJE 74,9
40 DTS /8E/ Ø10/12mm

103100GG010 / QDY1289

JHAEM

U14400



KIA RIO / MORNING
CX740/ CX760/CX820/CX840

REPARACIÓN UR0188
EJE 72,7- 49,6mm
40 DTS /8E/ Ø9,9mm

JM000A15001 / 36100-03400

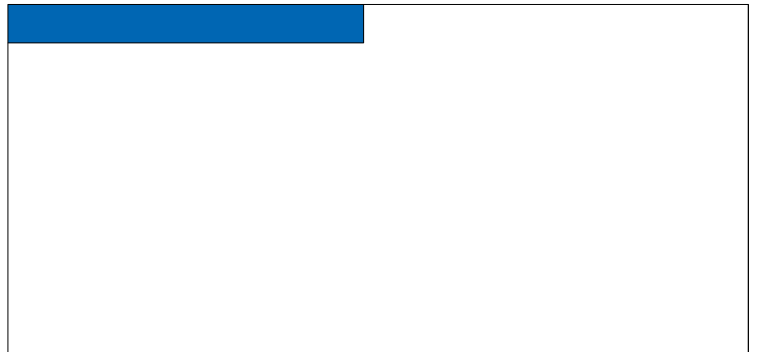
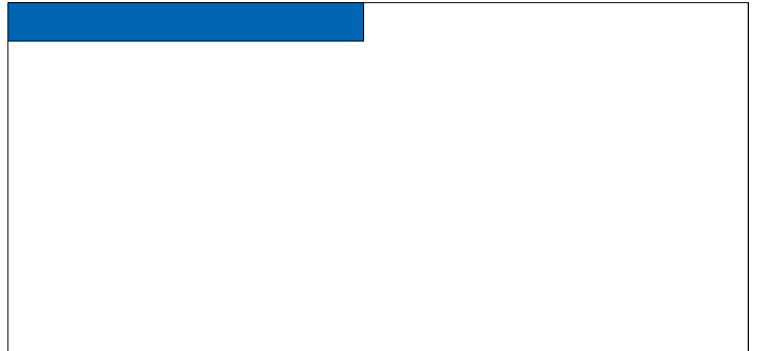
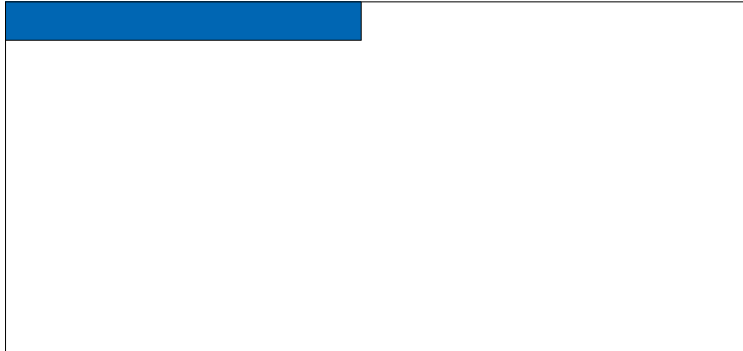



MOTORCRAFT

U13118



FORD FOCUS 1.6/2.0

**EJE 76,7mm
45 DTS /12E/ Ø11,9mm**

MOTORCRAFT

U13119



ZEN-12717

ESCORT/ FIESTA/ KA

**EJE 79,7mm
45 DTS /12E/ Ø12mm**

96BB11000AA

MOTORCRAFT

U13120



RANGER V6/ ECOSPORT

**EJE 89,5mm
37 DTS /12E/ Ø12mm**

F8TU11000 DD 9251-A1

MOTORCRAFT

U13121

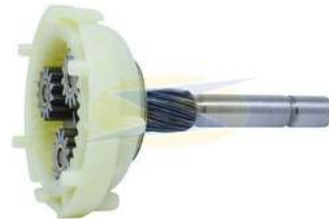

**FORD RANGER
EXPLORER 4.0**

**EJE 81,2mm
37 DTS /12E/ Ø12mm**

F07UAA716A

MOTORCRAFT

U13122



FORD F150/ F1000/F4000

**EJE 81,2mm 17,6mm
37 DTS /12E/ Ø12mm**

F2TUAA7C27A

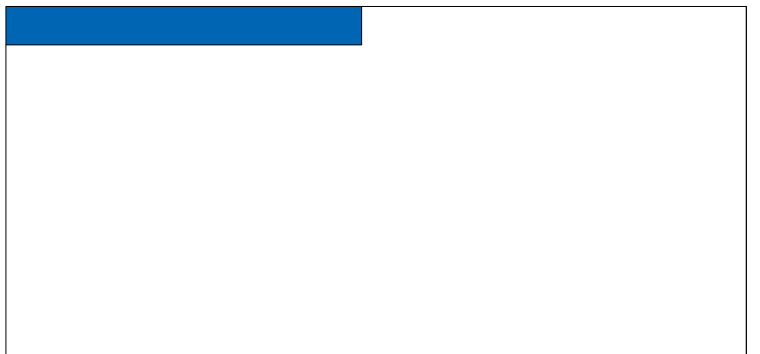
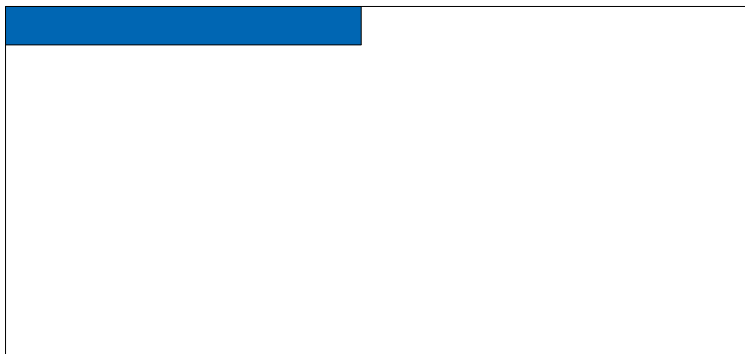
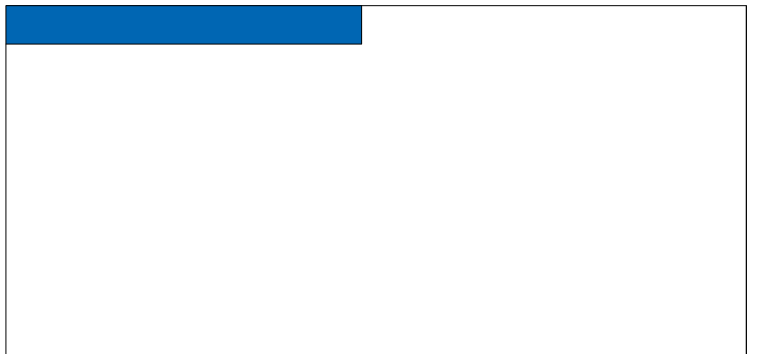
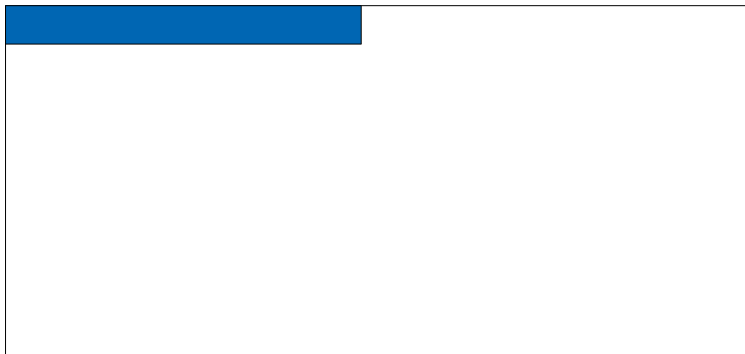



MITSUBISHI

U15100



**MAZDA MPV/NISSAN
S10**

**EJE 79mm
42 DTS /8E/ Ø12-9,9mm**

MITSUBISHI

U15101



**HORQUILLA MITSUBISHI/
CLARK/FORKLIFT**

**EJE 76,8mm
43 DTS /8E/ Ø9,9mm**

MITSUBISHI

U15103



**MITSUBISHI L200 SPORT
GM S10**

**EJE 77,5mm
44 DTS /8E/ Ø9,9-13mm**

M002T87771

MITSUBISHI

U15104



**HORQUILLA HYSTER/
FORKLIFT/RENAULT**

**EJE 77,5mm
44 DTS /8E/ Ø9,9-13mm**

MITSUBISHI

U15105



4M40

**MONTERO 2.8TD
CANTER**

**EJE 62,1mm
44 DTS /10E/ Ø12mm**

M008T75071A

MITSUBISHI

U15106



**IVECO EUROSTAR
FORD L6000/
VW 13-180/15-180**

**EJE 83,4mm
44 DTS /12E/ Ø14mm**

M9T61671

MITSUBISHI

U15107



MB AXOR / ACTROS

**EJE 87,3mm
46 DTS /12E/ Ø14mm**

MITSUBISHI

U15108



**VW CONSTELLATION
MAN SERIES 7/8/10/12/15**

**EJE 75mm
44 DTS /10E/ Ø12mm**

MITSUBISHI

U15109



**LOGAN / SANDERO
NISSAN TIIDA**

**EJE 75,4mm
42 DTS /8E/ Ø9,9-12mm**

M000TD1371ZE

MITSUBISHI

U15113



UR0165/ UR0180

FORD RANGER 2.2/ 3.2

**EJE 87,3mm
43 DTS /8E/ Ø13-10mm**

M002T86071ZT/ AB39-11000-



IMPORTADORA
ISIS

**Importación, Exportación
y Comercialización de Repuestos
de Vehículos**
Ignacio Carrera Pinto #1161, Rancagua.
Fono: 72-2-583570
ventas@importadoraisis.cl



PRESTOLITE

M100R



U12100

KO-1497

**AGRALE/ CUMMINS
VW OMNIBUS/ MBB**

**EJE 120,4mm
38 DTS /12E/ Ø15mm**

PRESTOLITE

M100R



U12101

KO-1561

JOHN DEERE

**EJE 81,7mm
48 DTS /12E/ Ø12mm**

PRESTOLITE

M93R



U12147

ZEN-12682

**OMNIBUS VOLARE/
BLAZER/ S10/ MWM/
FORD CARGO/ VW**

**EJE 98,4mm
39 DTS /10E/ Ø12mm**

PRESTOLITE

M93R



U12149

ZEN-12686

**MB OMNIBUS /
CUMMINS SERIE B**

**FORD/ DIMEX
EJE 120,9mm
39 DTS /10E/ Ø12mm**

PRESTOLITE

M93R



U12212

ZEN-12692

MERCEDES BENZ

**EJE 120,1mm
39 DTS /10E/ Ø14mm**

PRESTOLITE

M93R



U12219

ZEN 12687

VOLKSWAGEN

**EJE 136,4mm
39 DTS /10E/ Ø12mm**

PRESTOLITE

M93R



U12221

ZEN-12675

**M FERGUSON
FORD F250**

**EJE 98,9mm
39 DTS /10E/ Ø14mm**

PRESTOLITE

M93R



U12222

ZEN-12684

**DEUTZ/ JOHN DEERE/
PERKINS /MWM/MAXION
MASSEY FERGUSON**

**EJE 120,1mm
39 DTS /10E/ Ø14mm**

PRESTOLITE



U12225

UR0195/ UR0196

**FORD RANGER 2.3/
FORD FOCUS 2.0/**

**EJE 87,8mm
38 DTS /9E/ Ø11,9mm**

35261260

PRESTOLITE

M93R



U12343

ZEN-12688

**VW / FORD
CUMMINS**

**EJE 126,7mm
39 DTS /10E/ Ø14mm**



VALEO

U16101



**HYUNDAI HR/ ACCENT 1.5/
KIA /SPRINTER**

**EJE 98,9mm
56 DTS /9E/ Ø10-12mm**

36100-42350

VALEO

U16102



**CHEVROLET/RENAULT/
PEUGEOT/ CITROEN**

**EJE 82,6mm
37 DTS /10E/ Ø12mm**

D6RA85/ D6RA185

VALEO

U16103



**CHEVROLET/RENAULT/
PEUGEOT/ CITROEN**

**EJE 82,6mm
59 DTS /10E/ Ø12mm**

D6RA65/ D6RA165

VALEO

U16104



**SPRINTER/ CLIO/VITARA
PEUGEOT/ CITROEN
VW/ HYUNDAI HR**

**EJE 86,8mm
56 DTS /10E/ Ø10-12mm**

D7R11/ D7R15/DTR26

VALEO

U16105



**CLIO EXPRESS/ R19D
MEGANE/ LAGUNA
L200/ HR1**

**EJE 86,8mm
56 DTS /9E/ Ø10-12mm**

D7R11/ D7R15/DTR26

VALEO

U16106



RENAULT MASTER 2.2/2.5

**EJE 82,5mm
59 DTS /10E/**

D7G11/ 438170

VALEO

U16107



VW AMAROK 2.0 Tdi

**EJE 86,8mm
56 DTS /8E/ Ø9,9mm**

TS22ER12

VALEO

U16108



**KIA BONGO K2500
HYUNDAI H-1 2.5 CRDi
HR100**

**EJE 76,3mm
38 DTS /8E/ Ø10-12mm**

36100-4A200

VALEO

U16109



**MASTER III 2.3
S10 2.8/ TRAILBLAZER**

**EJE 80,6mm
56 DTS /8E/ Ø10mm**

TS22-32/ TS22E20

VALEO

U16110



**AUDI A4 2.0/ QUATTRO 2.0
VW TOUAREG**

**EJE 104,6-14mm
47 DTS /10E/ Ø10mm**

TS14E42 / 458405



VALEO



**U16111
GIRO IZQUIERDO**

VW GOL 1.6/ FOX 1.0
SPACE FOX / AUDI Q3

REPARACIÓN UR0191/R0192
EJE 78,3-43,8mm
46 DTS /8E/ Ø12mm

TCS10R6 / 02M911021J

VALEO



**U16112
GIRO IZQUIERDO**

VW GOL / SAVEIRO
POLO / FOX

REPARACIÓN UR0194
EJE 78,3-43,8mm
47 DTS /8E/ Ø12mm

TCS10R7 / VA495107

VALEO



U16113

SUZUKI IGNIS / SWIFT 1.3
FIORINO 1.3/ STRADA 1.3
PEUGEOT 307/ 206/

REPARACIÓN UR0194
EJE 78,2-16,6mm
47 DTS /10E/ Ø12mm

595660 / D6G3/ TS12E901

VALEO



U16114

NISSAN QASHQAI 1.6
VOLVO S60/ S80/ S90

REPARACIÓN UR0178
EJE 82-18,5mm
56 DTS /8E/ Ø10-12mm

31419530/ ESW20W11/

VALEO



U16115

BMW 320 2.0i

REPARACIÓN UR0202
EJE 98,8 – 15,9mm
43 DTS /8E/ Ø10mm

RSW22A12

VALEO



U16116

HYUNDAI H1 2.5 CRDI
KIA SORENTO 2.5 CRDI

REPARACIÓN UR0114
EJE 85,2
56 DTS /8E/ Ø12mm

361004A010 /600077

VALEO

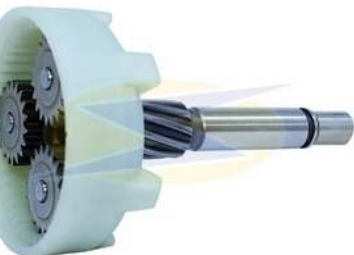

U16117

FORD ECOSPORT/
FOCUS 1.4/ 1.6/

REPARACIÓN UR0193/0194
EJE 78,2 – 14,8mm
47 DTS / 10E/ Ø10/12mm

TS12E10

VALEO



U16118

BMW 320 2.0i

REPARACIÓN UR0218
EJE 75,9 – 13,4mm
47 DTS /8E/ Ø10/12mm

TS1857/ 458768



BOSCH

UR0056
37 DIENTES



APLICACION: U11010/ U11015/ U11018/ U11128

BOSCH

UR0057
37 DIENTES



APLICACION: U11307

BOSCH

UR0058
36 DIENTES



APLICACION: U11161

BOSCH

UR0060
36 DIENTES



APLICACION: U11029

BOSCH

UR0062



**MBB / BMW/ FORD
RENAULT**

APLICACION: U11104

BOSCH

UR0075



**JUMPER 2.8/
DUCATO 2.3/2.8
HILUX SW4/ GOLF 1.9**

**APLICACION: 11220/1122
11143/ 11099/11111/11218**

BOSCH

UR0076
38 DIENTES



**DUCATO 2.3/2.8
STRADA 1.9D/ 1.7 TDS
MB 410 SPRINTER**

APLICACION: U11143/ U11099

BOSCH

UR0077
38 DIENTES



**JUMPER 2.8 HDI /
DUCATO 2.3/ BOXER 2.8**

APLICACION: U11218

BOSCH

UR0079



**MBB SPRINTER 515 Cdi
VW BORA/ POLO/ GOLF**

APLICACION: U11099/U11218

BOSCH

UR0080
37 DIENTES



APLICACION: U11010/ U11015/ U11018/U11037



BOSCH

UR0085
36 DIENTES



APLICACION: U11029

BOSCH

UR0086
37 DIENTES



APLICACION: U11059

BOSCH

UR0087
37 DIENTES

(U11104)



APLICACION: U11104

BOSCH

UR0094
37 DIENTES

ASTRA 2.2/ VECTRA 2.2
ZAFIRA



APLICACION: U11058

BOSCH

UR0105
42 DIENTES

VW GOLF 1.9 TDS



APLICACION: U11122

BOSCH

UR0106

DUCATO 2.8 TD/
IVECO DAILY
PEUGEOT BOXER



APLICACION: U11003/ U11090

BOSCH

UR0107
40 DIENTES

DUCATO 2.8 TD/
IVECO DAILY
PEUGEOT BOXER



APLICACION: 11003/11090

BOSCH

UR0108
38 DIENTES

VW BORA /GOLF/JETTA
TRANSPORTER/
SKODA/ MBB



APLICACION: 11117/11118

BOSCH

UR0109

SSANGYONG MUSSO/
TRANSPORTER 2.4D
DODGE DAKOTA 2.5D



APLICACION: 11067/11073/11590/11056

BOSCH

UR0110
42 DIENTES

BLAZER 2.2/ DUCATO
SSANGYONG/JUMPER



APLICACION: 11067/11073/11590/11056



**IMPORTADORA
ISIS**

**Importación, Exportación
y Comercialización de Repuestos
de Vehículos**
Ignacio Carrera Pinto #1161, Rancagua.
Fono: 72-2-583570
ventas@importadoraisis.cl



BOSCH

UR0112
42 DIENTES



**BLAZER 2.2/ DUCATO
SSANGYONG/JUMPER**

APLICACION: 11056

BOSCH

UR0116
40 DIENTES



FIAT BRAVO/STRADA

APLICACION: U11358 **0001121440**

BOSCH

UR0117
40 DIENTES



FIAT BRAVO/STRADA

APLICACION: U11358 **0001121440**

BOSCH

UR0118
37 DIENTES



**MBB SPRINTER 311
415/515 Cdi**

APLICACION: U11369 **F000AL0901/ 0903**

BOSCH

UR0119
37 DIENTES



**MBB SPRINTER 311
415/515 Cdi**
**METALICA O NYLON
SON EQUIVALENTES**

APLICACION: U11369 **F000AL0901/ 0903**

BOSCH

UR0120
37 DIENTES



MBB SPRINTER 210

APLICACION: U11215 **1006200125**

BOSCH

UR0121
42 DIENTES



**FIAT IVECO LAND ROVER
MBB/ FORD /GM**

APLICACION: U11067/U11073/U11590

BOSCH

UR0122
42 DIENTES



FIORINO DIESEL 1.7

APLICACION: U11025

BOSCH

UR0124
37 DIENTES



**FIAT DUCATO/ BOXER/
JUMPER**

APLICACION: U11079/11116 **0001115079**

BOSCH

UR0125
37 DIENTES



**VW GOL 1.6D/SAVEIRO
TRANSPORTER**

APLICACION: U11079/11116/11190/11039 **F010ALO103**



**IMPORTADORA
ISIS**

**Importación, Exportación
y Comercialización de Repuestos
de Vehículos**

Ignacio Carrera Pinto #1161, Rancagua.
Fono: 72-2-583570
ventas@importadoraisis.cl



BOSCH

**UR0126
36 DIENTES**

mmB CLASSE A
HYUNDAI TUCSON



APLICACION: U11120

0001115008

BOSCH

UR0127

FORD ESCORT/ MONDEO

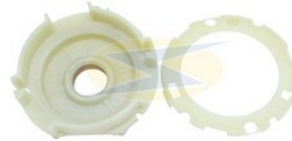

APLICACION: U11132

0001107016

BOSCH

**UR0128
40 DIENTES**

FIAT/ FORD/ IVECO



APLICACION: U111090/U11727/ U11003/ U11063

BOSCH

**UR0129
42 DIENTES**

FIORINO DIESEL 1.7



APLICACION: U11025

0001110025

BOSCH

**UR0130
42 DIENTES**

MBB MARCOPOLO



APLICACION: U11056

BOSCH

**UR0131
37 DIENTES**

FORD ESCORT 1.8/
MONDEO /FOCUS 1.8



APLICACION: U11132

1006200132

BOSCH

**UR0139
40 DIENTES**

FORD CARGO C1317/1319/
1517/1519/2622/2623



APLICACION: U11727

BOSCH

**UR0140
38 DIENTES**

MBB/ NEW HOLLAND
M FERGUSON/CASE/



APLICACION: U11779

BOSCH

**UR0141
38 DIENTES**

MBB/ NEW HOLLAND
M FERGUSON/CASE/



APLICACION: U11779

BOSCH

**UR0144
40 DIENTES**

VW BORA/ GOLF/ POLO
PASSAT/ NEW BEETLE



APLICACION: U11137



BOSCH

UR0148

36 DIENTES



TOYOTA COROLLA 1.8/ 2.0
PEUGEOT 107/
RENAULT DUSTER 2.0

APLICACION: U11477 /U11508

0001107433 / 0001107441

BOSCH

UR0149

36 DIENTES



TOYOTA COROLLA 1.8/ 2.0
PEUGEOT 107/
RENAULT DUSTER 2.0

APLICACION: U11477 /U11508

0001107433 / 0001107441

BOSCH

UR0152

37 DIENTES



FIAT UNO/ MOBI/ ARGO

APLICACION: U11421

0001170421

BOSCH

UR0159

37 DIENTES



BMW

BOSCH

UR0161



COROLLA 1.8 /2.0
BMW 116/ 118/ 316 1.6i

APLICACION: U11514

0001107514 / 0001107426

BOSCH

UR0168

42 DIENTES



BMW 116/ 118/ 120/ 316 1.6i
X3 2.0i/ 525 2.5iX

APLICACION: U11327

0001107426/ 0001107526

BOSCH

UR0170

53 DIENTES



FIAT DOBLO/ STRADA
COTOLLA 2.0

APLICACION: U11002

F000C60004/F000C60300

BOSCH

UR0171

53 DIENTES



FIAT DOBLO/ STRADA
COTOLLA 2.0

APLICACION: U11002

F000C60004/F000C60300

BOSCH

UR0172

37 DIENTES



AUDI / SEAT/ SKODA
11663

APLICACION: U11367

0001121402/ 0001121435

BOSCH

UR0173

42 DIENTES



BMW 116/ 118/ 120/ 316 1.6i
X3 2.0i/ 525 2.5iX

APLICACION: U11327

0001107426/ 0001107526



BOSCH

**UR0187
37 DIENTES**



**MBB SPRINTER 213 2.2
SPRINTER 413/ 513 2.2
FIAT TORO/ DOBLO 1.6**

APLICACION: U11956

0001108420/ F000AL0901

BOSCH

**UR0219
37 DIENTES**



**SSANGYONG REXTON 2.7
CHEVROLET OMEGA V6**

APLICACION: U11009

9000061009/ 92046275

BOSCH

**UR0220
37 DIENTES**



**SSANGYONG REXTON 2.7
CHEVROLET OMEGA V6**

APLICACION: U11009

9000061009/ 92046275

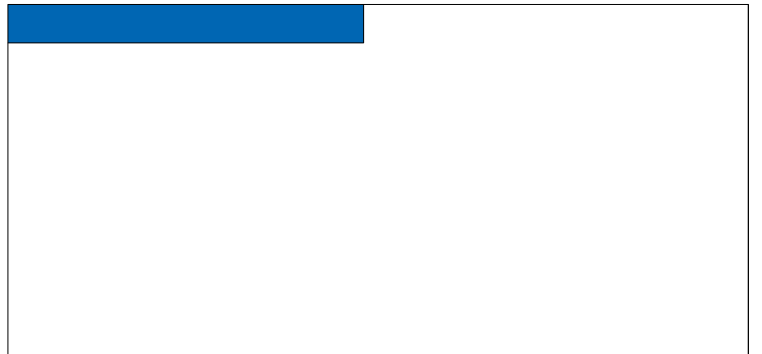
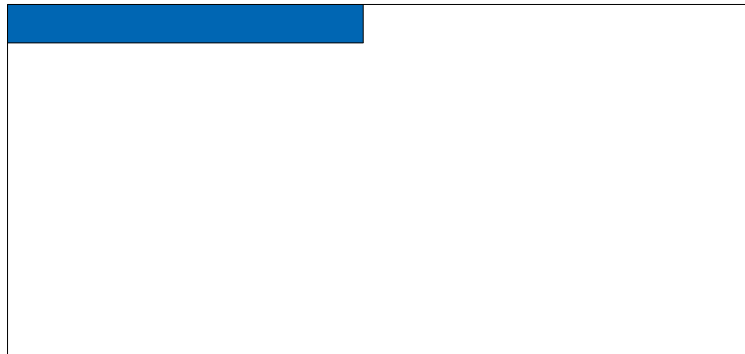
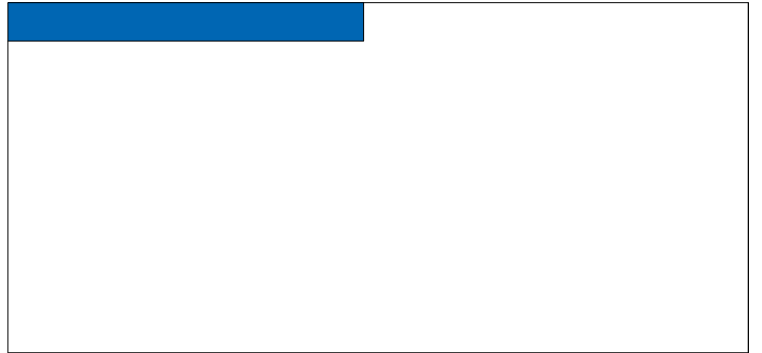
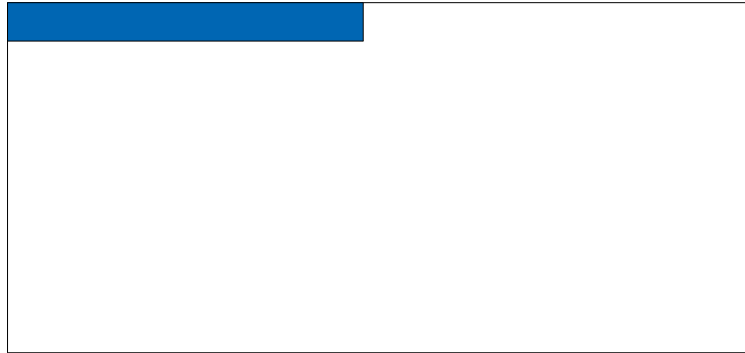
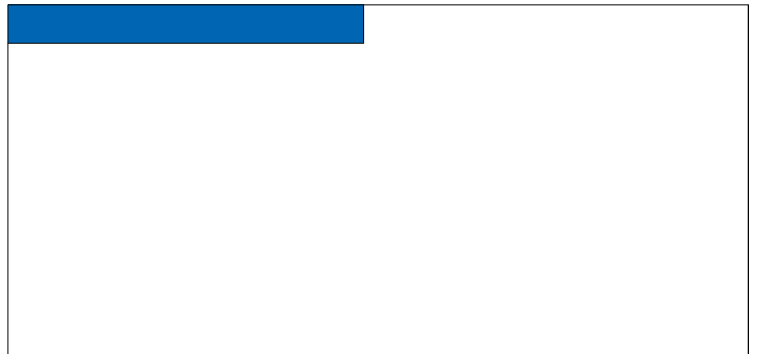
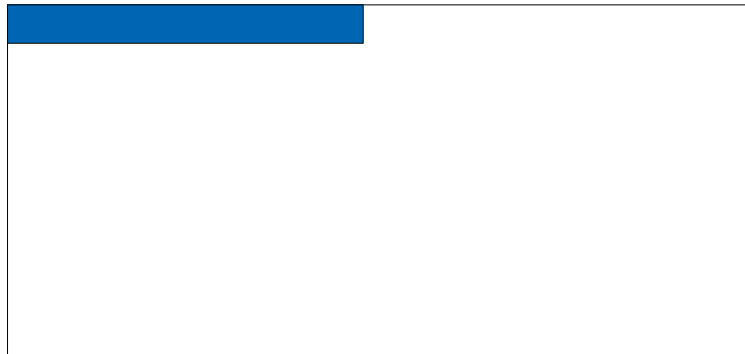



DELCO

**UR0132
42 DIENTES**



**KIA SORENTO / SPORTAGE
HYUNDAI TUCSON**

APLICACION: U14057

36100-2G000

DELCO

**UR0064
50 DIENTES**



ASTRA/ BLAZER/ S10

APLICACION: U14368

9000890/ 9000893

DELCO

**UR0065
48 DIENTES**



APLICACION: U14910

DELCO

**UR0071
43 DIENTES**



BLAZER/ S10/

APLICACION: U14890

DELCO

**ZEN 12721
UNIFAP UR0088**



50 DIENTES

APLICACION: U14150

DELCO

**UR0089
50 DIENTES**



APLICACION: U14368

DELCO

**UR0097
43 DIENTES**



BLAZER / S10

APLICACION: U14890

8000034/ 9000973

DELCO

**UR0177
50 DIENTES**



CHERY TIGGO 2.0

QDJ1266A

DELCO

**ZEN 12722
UNIFAP UR0063**



50 DIENTES

APLICACION: U14150

DELCO

**UR0182
42 DIENTES**



**HYUNDAI HR 2.5/ H1 2.5
KIA BONGO K2500**

APLICACION: U14534

8000534/ 36100-4A150



**IMPORTADORA
ISIS**

**Importación, Exportación
y Comercialización de Repuestos
de Vehículos**

Ignacio Carrera Pinto #1161, Rancagua.
Fono: 72-2-583570
ventas@importadoraisis.cl



DELCO



**UR0183
46 DIENTES**

HYUNDAI HR 2.0/ H1 2.5
KIA BONGO K2500

APLICACION: U14868

8000868/ 36100-4A160

DELCO



**UR0211
35 DIENTES**

HYUNDAI HB20 1.0
KIA RIO 1.0

APLICACION: U14417

36100-04270



DENSO



**UR0136
42 DIENTES**

MB C180/220
SPRINTER 213/313

APLICACION: U17420

428000-8420

DENSO



**UR0151
41 DIENTES**

FIAT UNO/ ARGO/
MOBI/ PALIO

APLICACION: U17210

BC428000-9500/ 80023936

DENSO



**UR0163
55 DIENTES**

TOYOTA RAV4/ CAMRY

428000-5880

DENSO



**UR0164
42 DIENTES**

BMW

APLICACION: U17490

428000-4490

DENSO



**UR0167
37 DIENTES**

FIAT BRAVO 1.6
PALIO WEEKEND

DENSO



**UR0169
37 DIENTES**

BMW X1/ 200I/ 225I
NEW CIVIC 1.8/2.0

Ø66,3mm
438000-0471/428000-8190

DENSO



**UR0186
31 DIENTES**

DODGE RAM 2500 5.9
RAM 3500/ 4000 5.9

428000-1190

DENSO



**UR0190
43 DIENTES**

HONDA ACCORD 2.0
JEEP WRANGLER 3.8L
HONDA CR-V 2.0

APLICACION: U17011/ U17640

428000-6640

DENSO



**UR0197
42 DIENTES**

SPRINTER 213/313/316
VITO 113/ 116
TOYOTA HILUX

428000-8420

DENSO



**UR0198
41 DIENTES**

CATERPILLAR 320D
JOHN DEERE 370E/

APLICACION: U17414

428000-0130



DENSO



UR0199
39 DIENTES

RAM 2500 5.9/ 6.7
RAM3500 5.9/
HINO 268 7.6

APLICACION: U17330

428000-3330/ 428000-9340

DENSO



UR0200
55 DIENTES

TOYOTA RAV4 /
AVENSIS 2.4/

APLICACION: U17190

428000-5880/ 22800-9901

DENSO



UR0201
37 DIENTES

BMW X1/ 216i/ 218 1.5

Ø65,9mm

APLICACION: U17471

438000-0417/ 438000-0470

DENSO



UR0203
37 DIENTES

HONDA ACCORD 3.5/
NEW CIVIC 1.8/ 2.0
PILOT / ODYSSEY 3.5

Ø66,3mm

APLICACION: U17190

428000-5380/ 428000-8190

DENSO



UR0206
37 DIENTES

RANGE ROVER SPORT/
DISCOVERY 2.7/

APLICACION: U17950

428000-5950

DENSO



UR0207
37 DIENTES

RANGE ROVER SPORT/
DISCOVERY 2.7/

APLICACION: U17950

428000-5950



**IMPORTADORA
ISIS**

**Importación, Exportación
y Comercialización de Repuestos
de Vehículos**

Ignacio Carrera Pinto #1161, Rancagua.
Fono: 72-2-583570
ventas@importadoraisis.cl



HITACHI



**UR0175
40 DIENTES**

**FIAT PALIO 1.0/1.3/1.4/
STRADA 1.3/1.4/
PUNTO 1.0/1.3/1.4/**

S114-951A/ 51899848



ISKRA

**UR0146
42 DIENTES**



**BOBCAT/ JOHN DEERE
CASE/ KOMATSU/ MBB
NEW HOLLAND/ VALMET**

APLICACION: U18832

AZF4527/ AZF4129/

ISKRA

**UR0150
38 DIENTES**



**JCB/ BOBCAT/ IVECO
M FERGUSSON/ ZETOR
VALTRA/ N HOLLAND**

APLICACION: U18623

AZE4169/ AZE4261

ISKRA

**UR0156
42 DIENTES**



JCB

APLICACION: U18446

AZF4181/ AZF4224/ AZF4301

ISKRA

**UR0160
41 DIENTES**



**HATZ 1B40 05/
JCB 4.4/ 4.8**

APLICACION: U18944

11131995/11132230

ISKRA

**UR0184
38 DIENTES**



**VOLVO/ ATLAS COPCO/
HAMM/ KRAMER/ KHD**

APLICACION: U18628

11131948/11132027

ISKRA

**UR0215
42 DIENTES**



**NEW HOLLAND CX720
CX740/ CX760/ CX780/ CX820**

APLICACION: U18979

AZF4524/ AZF4595/ 11131370

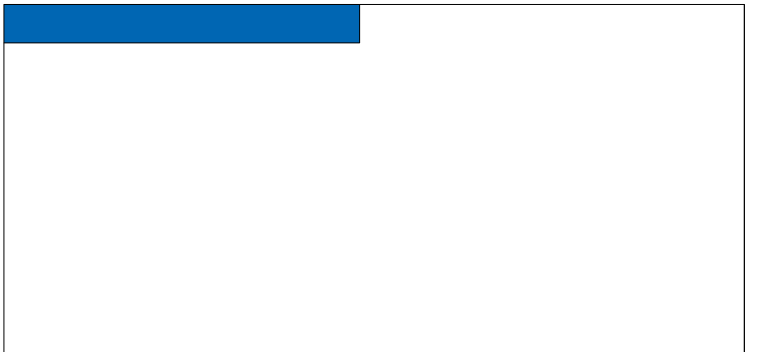
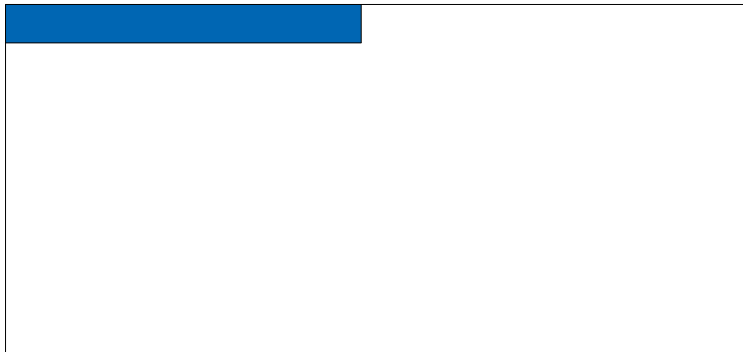
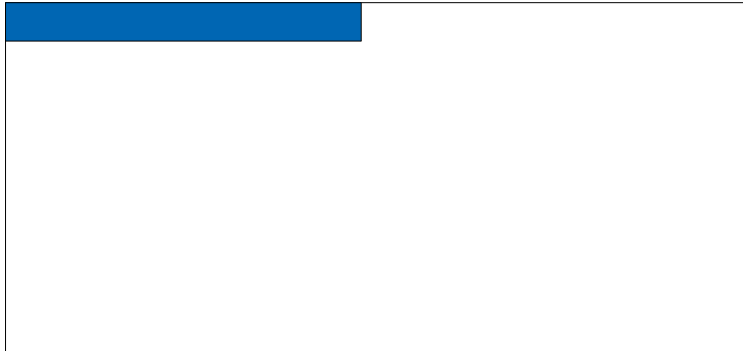



COMSTAR



UR0157
42 DIENTES

RENAULT DUSTER/
LOGAN / SANDERO

APLICACION: U13123

233004485R/233006904R

JHAEM



UR0185
40 DIENTES

KIA RIO / HYUNDAI i10/
i20 1.2

JM000A15001/36100-03400

JHAEM



UR0188
40 DIENTES

KIA RIO / HYUNDAI i10/
i20 1.2

JM000A15001/36100-03400

JHEECO



UR0204
38 DIENTES

JAC J3 1.4/ J5

APLICACION: U14104

1043100GGG01C

JHEECO



UR0205
38 DIENTES

JAC J3 1.4/ J5

APLICACION: U14104

1043100GGG01C

JHAEM



UR0213
40 DIENTES

JAC J2/ J3 1.4

APLICACION: U14289

103100GG010 / QDY1289

JHAEM



UR0214
40 DIENTES

JAC J2/ J3 1.4

APLICACION: U14289

103100GG010 / QDY1289

JHAEM

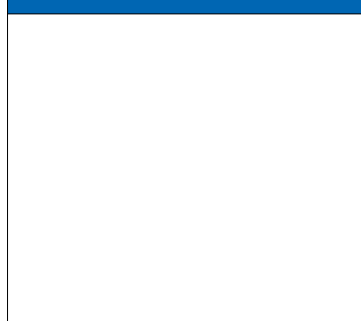

JHEECO

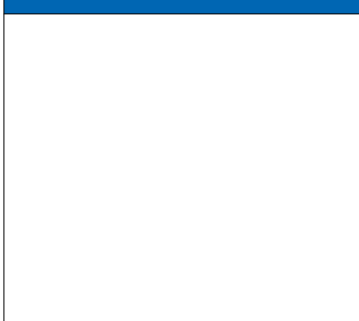



MOTORCRAFT

**ZEN 12719
UNIFAP UR0059**



**45 DIENTES
(U13119)**

APLICACION: U13119

MOTORCRAFT

**UR0067
37 DIENTES**



APLICACION: U113120/ U13121/ U13122

MOTORCRAFT

**ZEN 12718
UNIFAP UR0084**



45 DIENTES

APLICACION: U13119

MOTORCRAFT

UR0093



37 DIENTES

APLICACION: U13120/ U13121/ U13122

MOTORCRAFT

UR0212



**45 DIENTES
FORD EDGE 3.5 V6/**

APLICACION: U13117

MOTORCRAFT

UR0074



**FORD ESCORT/ FIESTA/ KA
FOCUS 1.6/ 2.0**

APLICACION: U13118 / U13119



**IMPORTADORA
ISIS**

**Importación, Exportación
y Comercialización de Repuestos
de Vehículos**
Ignacio Carrera Pinto #1161, Rancagua.
Fono: 72-2-583570
ventas@importadoraisis.cl



MITSUBA



**UR0166
41 DIENTES**

**HONDA NEW FIT /
NEW CITY/ NEW CIVIC**

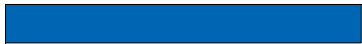



IMPORTADORA
ISIS

**Importación, Exportación
y Comercialización de Repuestos
de Vehículos**
Ignacio Carrera Pinto #1161, Rancagua.
Fono: 72-2-583570
ventas@importadoraisis.cl



MITSUBISHI

UR0066
43 DIENTES



APLICACION: U14711

MITSUBISHI

UR0070
42 DIENTES



APLICACION: U15100

MITSUBISHI

UR0072
43 DIENTES



MITSUBISHI

UR0073
42 DIENTES



APLICACION: U15104

MITSUBISHI

UR0096
42 DIENTES



S10/ VOLARE/ NISSA

APLICACION: U15100

MITSUBISHI

UR0098
42 DIENTES



RENAULT/ HYSTER

APLICACION: U15104 / UR0103

MITSUBISHI

UR0099
43 DIENTES



**NISSAN/ SUBARU/
SUZUKI**

MITSUBISHI

UR0100
43 DIENTES



APLICACION: U14711

MITSUBISHI

UR0101
44 DIENTES



**JEEP WRANGLER/
GRAND CHEROKKE
CANTER 2.5D/ L200 2.5D
GRAN VITARA 1.6**

APLICACION: U15103

M002T87771/ MD344183

MITSUBISHI

UR0102
44 DIENTES



MBB / L200/ GM S10

APLICACION: U15103



MITSUBISHI

UR0103



(U15101/U15103/U15104)

MITSUBISHI

UR0137

44 DIENTES



VW CONSTELLATION
VOLVO PENTA D4/D6
IVECO 180E/190S

APLICACION: U15108

M8T62671/ M008T55779

MITSUBISHI

UR0142

44 DIENTES



VW CONSTELLATION
MAN SEIRES 7/8/10/12/18

APLICACION: U15108

MITSUBISHI

UR0155

42 DIENTES



SANDERO / LOGAN
NISSAN TIIDA

APLICACION: U15109

M000TD1371ZE

MITSUBISHI

UR0154

41 DIENTES



FORD FUSION 3.0
COLORADO/ TRAVERSE 3.6

APLICACION: U15102

M000T16271ZC

MITSUBISHI

UR0165

43 DIENTES



FORD RANGER 2.2/ 3.2 Tdi

APLICACION: U15113

M002T86071ZT

MITSUBISHI

UR0176

44 DIENTES



CRUZE / TRACKER/
ASTRA

12673600/ 695085118

MITSUBISHI

UR0180

43 DIENTES



FORD RANGER 2.2/ 3.2 Tdi

APLICACION: U15113

M002T86071ZT

MITSUBISHI

UR0210

43 DIENTES



MITSUBISHI ASX 1.8/
LANCER 1.8/
OUTLANDER 1.8/ 2.4

APLICACION: U15114

M000TC0271

MITSUBISHI

UR0216

41 DIENTES



FORD FUSION 3.0/
SUZUKI IGNIS 1.3/ 1.5/
CHEVROLET CAPTIVA 3.6

APLICACION: U15102

M000T16271ZC



**IMPORTADORA
ISIS**

**Importación, Exportación
y Comercialización de Repuestos
de Vehículos**
Ignacio Carrera Pinto #1161, Rancagua.
Fono: 72-2-583570
ventas@importadoraisis.cl



MITSUBISHI

**UR0217
42 DIENTES**



**RENAULT SANDERO/
LOGAN /
NISSAN VERSA**

APLICACION: U15109

M000TD1371ZE



PRESTOLITE

**ZEN 12695
UR0082**



37 DIENTES

**AGRALE / CUMMINS/
BLAZER**

APLICACION U12147/ U12222/ U12343

PRESTOLITE

UR0095



**U12147/U12149/U12212/
U12219/U12221/U12222/
U12223**

PRESTOLITE

**UR0104
38 DIENTES**



**FORD CUMMINS C 8.3
CUMMINS/ AGRALE**

APLICACION: U12100

PRESTOLITE

UR0134



M93R

APLICACION U12147/ U12149/ U12212/ U12222

PRESTOLITE

UR0135



**FORD CUMMINS C 8.3
CUMMINS/ AGRALE**

APLICACION: U12100 / U12101

PRESTOLITE

**UR0147
39 DIENTES**



**MBB /FORD CARGO
CUMMINS**

APLICACION: U12412 / U12419/ U12421/U12449/

PRESTOLITE

**UR0195
38 DIENTES**



**FORD RANGER
CITROEN BERLINGO
AGRALE / DEUTZ**

AP:U12223/U12225/U12227

352584030

PRESTOLITE

**UR0196
38 DIENTES**



**FORD RANGER
CITROEN BERLINGO
AGRALE / DEUTZ**

AP:U12223/U12225/U12227

352584030



VALEO



**UR0068
37 DIENTES**

**RENAULT/PEUGEOT
CITROEN**

APLICACION U16102

VALEO



**UR0069
59 DIENTES**

**CORSA/ CLIO 1.8/
KANGOO**

APLICACION U16103

VALEO



**UR0113
59 DIENTES**

**RENAULT MASTER 2.5/
2.8 2006**

APLICACION U16106

D7G11

VALEO



**UR0114
56 DIENTES**

**HYUNDAI H1
ACCENT 1.5 CRDi
MBB SPRINTER**

APLICACION U16101

36100-42350

VALEO



**UR0115
56 DIENTES**

**VOLKSWAGEN AMAROK
2.0 Tdi**

APLICACION U16107

TS12ER15/ TS22ER12

VALEO



**UR0174
40 DIENTES**

FORD ECOSPORT 2.0 16V

FS14B2

VALEO



**UR0178
56 DIENTES**

**QASHQAI 1.6/ SCENIC 1.6
VOLVO S60/ S80/ S90**

APLICACION U16114

ESW20E26/ ESW20E3

VALEO



**UR0179
47 DIENTES**

**VW CROSSFOX/ SPACEFOX
GOLF/ POLO/SAVEIRO 1.6**

VALEO



**UR0191
46 DIENTES**

**VW GOL /FOX/ TOURAN
TRANSPORTER/ CROSS
SKODA**

APLICACION: U16111

TSC10R6/ 02M911021J

VALEO



**UR0192
46 DIENTES**

**VW GOL /FOX/ TOURAN
TRANSPORTER/ CROSS
SKODA**

APLICACION: U16111

TSC10R6/ 02M911021J



VALEO



**UR0193
47 DIENTES**

**VW GOL / SAVEIRO/POLO
GOLF**

APL: U16113/U16112/U16110

TSC10R7/ VA495107

VALEO



**UR0194
47 DIENTES**

**VW GOL / SAVEIRO/POLO
GOLF**

APL: U16113/U16112/U16110

TSC10R7/ VA495107

VALEO



**UR0202
43 DIENTES**

BMW 320i

APLICACION: U16115

RSW22A12

VALEO

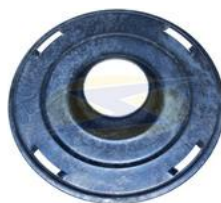

UR0208

**KIA BONGO/ SORENTO
MBB SPRINTER/ VITO
MITSUBISHI/ NISSAN**

APL:U16101/U16104/U16105/U16109

D7R12/ D7R28/ D8R29

VALEO



**UR0209
56 DIENTES**

**SPRINTER/ CLIO/VITARA
PEUGEOT/ CITROEN
VW/ HYUNDAI HR**

APLICACION: U16104

D7R11/ D7R20/ D7R27

VALEO



**UR0218
47 DIENTES**

**VOLVO S60/ V40/ V60/ V90
XC60 / XC90**

APLICACION: U16118

438329 / RSM14-10/ TS1857

